

Haier

User's Manual Fully Automatic Washing Machine

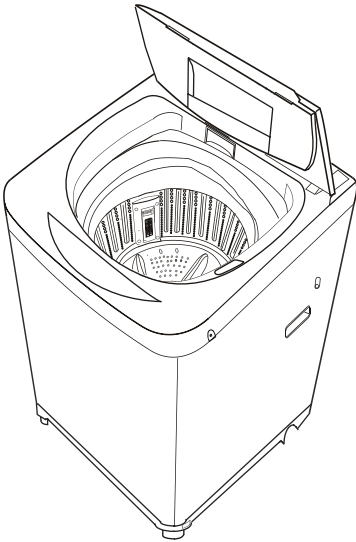

This manual is for
HWM85-7288

Index

- Safety precautions 2
- Packing list 4
- Names of the parts..... 4
- Installation and
adjustment..... 5
- Preparation before
washing9
- Use the operation buttons 11
- Disposal after washing 13
- Trouble-shooting Answer
to question..... 14
- Specification..... 15

- Please read this manual carefully before using.
- Retain it for future reference.

Safety precautions

Meaning and description of the symbols



WARNING

Contents marked with that symbol are related to the safety of the product and the personal safety of the users. Please operate in strict conformity to the contents, otherwise it may cause damage of the machine or injure the personal safety of the user.



FORBIDDING

Contents marked with that symbol are actions forbidden to perform. Performing of those actions may result in damage of the machine or injure the personal safety of the user.

- Please check if power receptacle has good earthing condition before using to guarantee your safety.
- Please check if the water faucet is open, and if the connection of the water inlet pipe is proper.
- It is suggested to use foamless washing powder.
- Please don't use the washer in the environment below 0 °C; if the washer has been stored below 0°C, please be sure to ensure the washer is placed under the room temperature more than 2 hours and then use otherwise the washing effects may be lowered or the washer may be damaged.



- Please insert the power cord into special receptacle with rated voltage. Be sure to use single-phase three pins receptacle. The earthing terminal of the receptacle must be earthed reliably. If possible, please adopt electric leakage protector.
- The washing machine must be positioned so that the plug is accessible. Be sure to pull the plug off and close the water faucet in following cases: power failure, delivering the machine, setting the machine idle or cleaning the machine.
- Do not plug or pull the power plug with wet hand.
- Do not bend ,extend, twist, bind by force. Do not press or nip it with weight.
- Keep the pin of the power plug clean, if the power plug is polluted with dust, please wipe with dry cloth carefully.
- If the supply cord is damaged, it must be replaced by the manufacturer or its service agent or a similarly qualified person in order to avoid a hazard.



- Do not let the machine share one receptacle with other electric appliances. If the plugging into the receptacles loose, do not use the plug any more.

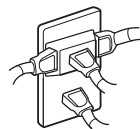



- In case the washing machine is installed on ground with carpet, do not block the ventilation hole with carpet. Ensure carpet does not obstruct the opening in the bases.

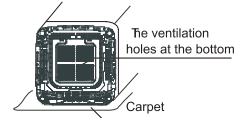

- Do not put the machine at damp place like the bathroom. Never wash it with water. Do not put wet laundries on the control panel.

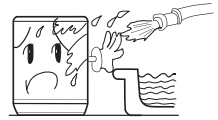

- Do not wash water-proof laundries like the raincoat, bike covers etc. to avoid abnormal vibrations in spinning. Wash the clothes that can float on the water surface easily, please be careful especially, for fear damage.



- Do not stretch hands into the working machine. It is dangerous even if the rotation is slow. Take special care of the children.



- Do not put any hot or heavy items (such as the kettle with hot water) on the washing machine.



- Do not wash laundries with volatile materials (such as thinner, petrol etc.)



- The children shall not approach the working washing machine.

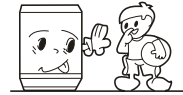

- Keep the machine away from direct sunlight and heat source like the heater.



- Do not decompose, repair or alter the machine by yourself.



- Do not use water hotter than 50 °C.



Packing list



Fully automatic washing machine

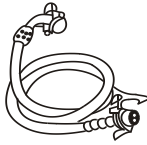

Water inlet hose

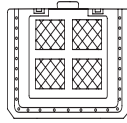

Bottom plate



Tapping screw

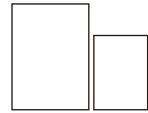

User's manual
Warranty card

Names of the parts

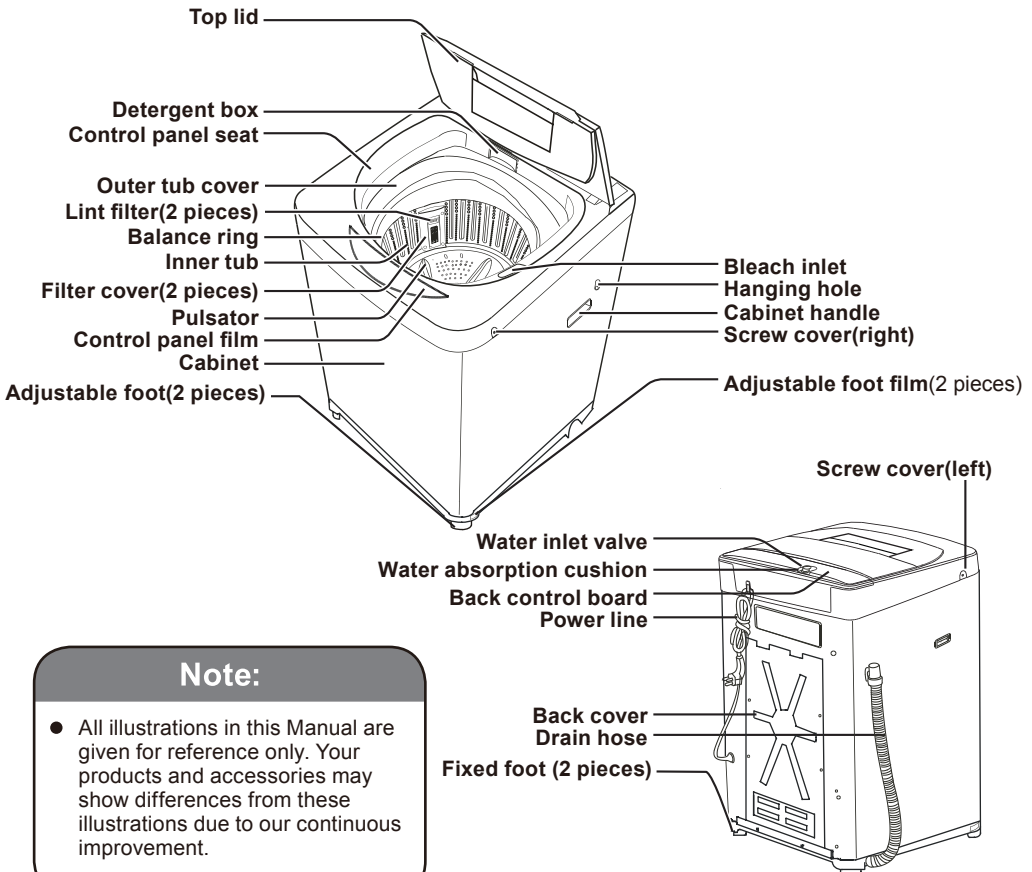

Installation and adjustment

Please install and adjust the machine according to the requirement of the manual. It is very important to your security and correct operating the machine.

Install the bottom plate

After you open the package, please lean the washing machine gently down on soft items (like the towel cloth, blanket, ect.). Install the bottom plate to the bottom of the machine, then lift the machine up gently. See to the figure:

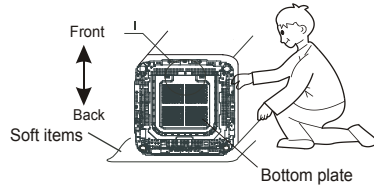

Two claws at the bottom cover shall be inserted in two bar-shaped holes in the stand. Make sure the claws are firmly in place.

Fasten the bottom plate to base frame with one screw

Section I enlarging

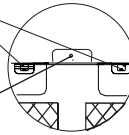

Adjust the Installation position

The washing machine away from wall should be overrun 20mm. The largest allowable slope of the shank base of the machine is 2° . The slanting or rough ground will result in unstable running or stoppage of the machine. Please adjust it with following methods:

- Confirm it's horizontal:
Hang the lead line to check if it is horizontal.

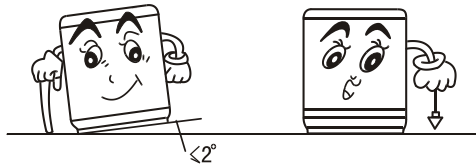

- Adjust the adjustable foot:

To twist the adjustable foot, please first lift up the side of the foot slightly, and then you can twist the two adjustable feet. Please make sure to keep the washing machine in balance.

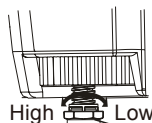

The adjustable foot

Install the water inlet hose

NOTE:The appliance is to be connected to the water mains using new hose-sets and that old hose-sets should not be reused.

Confirm the water faucet

- It is required that the front end shall be longer than 10mm.
- The exit end face of the faucet shall be flat and smooth.If not please file it to avoid leakage.

water faucet, suitable

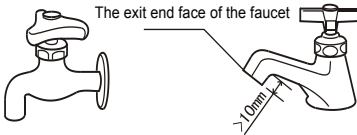

water faucet, not suitable

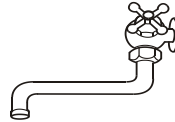

Connection between the water inlet hose jointer and the water faucet

1.Press the lower end of the lock lever and push down the slider. Take off the water inlet hose jointer from the water inlet hose component. See to Figure 1.

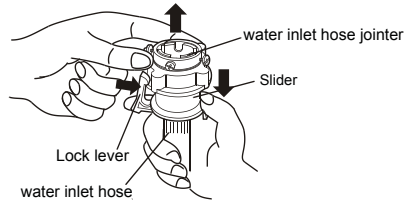

Figure 1

2.Loosen the screw till the water faucet can be accessed. Put the jointer of the water inlet hose on the faucet. See to Figure 2. (If the faucet is too large and the jointer can not be set on the water faucet,please loosen the four screws and take out the bushing in the jointer. The front end of the faucet must be smooth, otherwise it may leak water. See to Figure 3.)

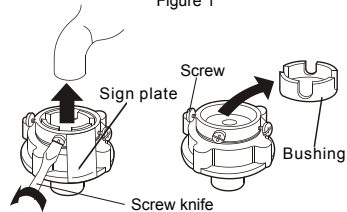

Figure 2

Figure 3

3.Fasten the four screws evenly. See to Figure 4.

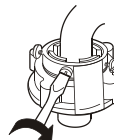

Figure 4

4.Take off the nameplate. Twist the fastening nut as per the indication of the figure to seal up the exit end face of the faucet. See to Figure 5. Remark: Before installation, the threading is 4mm above the upper surface of the nut.After installation, the threading is 2mm above the upper surface of the nut.See to Figure 6.

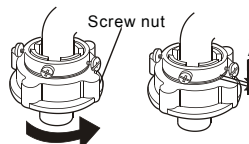

Figure 5

Figure 6

About 4mm before twisting
About less than 2mm after twisting

Connection between the water inlet hose and the washer

1. Do not take off the water absorption cushion. Please check if the cushion is dropped or damaged before each usage. If it happens please contact our after-sale department immediately.
2. Put the nut of the water inlet hose on the valve jointer.
3. Fasten the nut. Swing it gently to confirm if it's suitable.

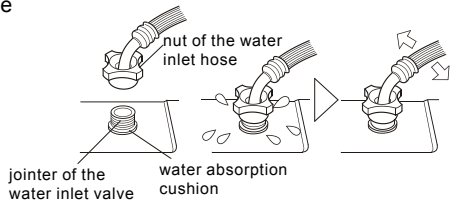

Connection between the jointer of the water inlet hose and the water inlet hose

1. Push down the slider. Insert the water inlet hose into the jointer.
2. Hang the lock lever to the jointer. Release the slider till a click sound is heard.

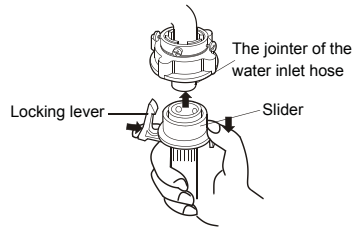

Check the connection between the jointer of the water inlet hose and the water faucet

1. Swing the hose gently to confirm if it is fastened stable.
2. After installation, open the faucet to check if it leaks.
3. Do not bend the hose with overstrain.
4. Before each usage please check if the connection between the jointer of the water inlet hose and the water faucet, and the installation of the water inlet hose are firm, so as to prevent dropping from improper installation position.

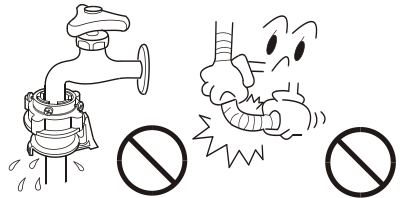

Dismantle the water inlet hose

1. Close the water faucet.
2. Press the locking lever. Push down the slider. Then pull off the water inlet hose. If the machine is used frequently, the jointer of the water inlet hose can be kept on the faucet to prevent damaging the fixing screw.

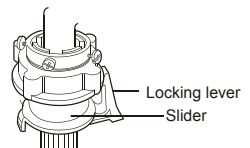

How to change the direction of the drain hose

1. Please lean the washing machine gently down on soft items (like the towel cloth, blanket, etc.)
2. Remove the Drain hose from the fixing clamp of the base frame.
3. Fix the drain hose in the fixing clamp on the other side.
4. Lift the machine up gently.

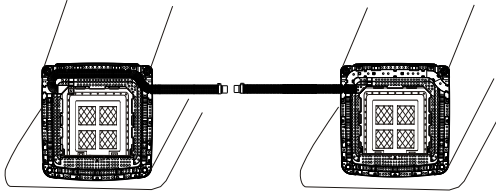

Remark: In order to make sure of the correct of installation, it is suggested to change the direction of the drain hose with our company serviceman.

Usage of the drain hose

The drain hose shall drain smoothly.

1. The height of the drain hose shall be less than 10cm, or the drainage will not be smooth, and cost such long time that the machine may stop at mid way.
2. Do not trample or press the drain hose.

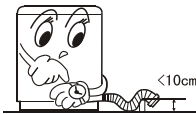

3. If the drain hose is too long, cut it at mid point. To make smooth drainage, cut the front end of the hose slantingly.



4. If extra drain hose is needed, please make separate purchase. The inner diameter of the extra hose shall not less than 30mm, and the length shall not exceed 1.5m.

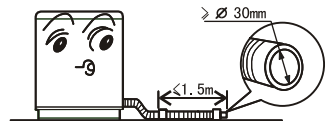

5. If the extra hose is too long, cut it either at A or at B point.

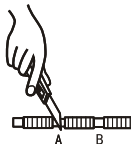

Preparation before washing

- Connect the water inlet hose. Open the water faucet.
- Confirm that the washing machine is earthed reliably. Then insert the power plug into the receptacle. The earth terminal shall not link to gas pipeline and faucet water pipeline.
- Put down the drain hose.
- Slanting or uneven ground may result in unstable working or abnormal noise. Please make the machine stand horizontally.

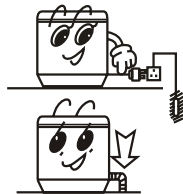

Pay attention to followings before washing the laundries

Confirm if there is special requirement for the laundries.

Clear the pocket. Take out the coins,sand, hairpins etc.



Tie the long strips; fasten the buttons;close zippers.



The quantity of the laundries shall not be too large. Stretch and loosen the laundries before putting them in the tub.



When the pulsator is running, the buttons of the laundries may cause noise. For the sake of discretion, please put the laundries with buttons into other laundries.



- Check if the laundries are applicable for washing with machine.
- Please repair the damaged cloth before washing in order to avoid the situation worse.
- Divide the laundries that are not colorfast from other laundries.
- Put those laundries difficult to absorb water into water with hand.
- For those laundries with heavy soil, please first remove the dirt like mud or dust. For the parts with heavy soil, please apply detergent on them in advance, which can make it easier to remove the soil.
- For those laundries that may get lint ball and those with long fur, turn it over before putting in.
- Do not put those laundries polluted by chemicals into the washing machine directly.
- The foreign materials will result in damage of the machine.

Put in the laundries

- The capacity of washing and spinning of the machine refer to the largest weight of the standard laundries under dry condition that can be washed or spun in one time. One time washing quantity shall be lower than the rated capacity.
- The thickness, size, type of the cloth will influence the actual washing capacity. It is suitable for one time washing to put in reasonable amount of laundries and the laundries can be turned round in washing.
- Do not select the high water level for laundries less than 1.0kg, so as to avoid splashing of water.



Usage of the detergent

How to use the washing powder and Softner

- Directly dissolved in the machine: (not applicable for fuzzy program)
 1. Fill small quantity of water.
 2. Add the powder. Run for 30 seconds to dissolve it completely.
 3. Put it in the laundries. Select suitable water level.
- The instant dissolving of the washing powder:
 1. Prepare warm water of 30 °C and a container.
 2. Add the powder while stirring to fully dissolve it.
- The super quick program, it is suggested to adopt liquid detergent instead of washing powder to guarantee the washing effect.
- Put in the proper quantities detergent according to the water level and the laundries quantities.
- It is suggested not to use high sudsing detergent. Washing powder with poor quality or long time storage maybe caked. Please pay attention to cleaning the detergent box in time.

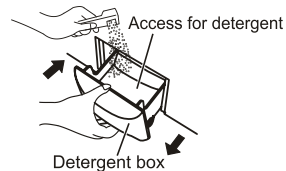

How to use the softener

- The usage and dose of the softener as per the specifications of softener.
- Turn the inner tub, you will find a softener inlet as the figure 1, open the cover, put the softener into the inlet as the figure 2. Before washing, close the cover and the softener will drop into the inner tub during the last time rinsing.
- After the softener is put in, please don't place for a long time otherwise softener may solidify and cause flowing not smooth.
- Don't put in the softener if the quick program is selected.

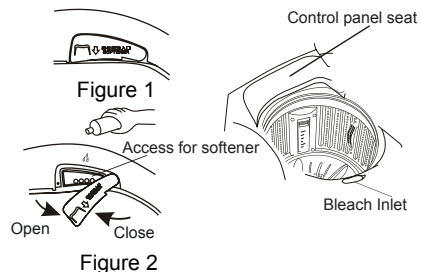

How to use the whitener

- Fill water to decided level. Dilute the whitener with container. Pour it slowly into the washing tub.
- Avoid using whitener on laundries with color or pattern as they are prone to lose color.
- The whitener shall not touch the laundries directly.
- Refer to the user's manual for the usage and quantity of the whitener.
- For powder whitener, please dissolve it before using.

Use the operation buttons

Description of the function of buttons

- Off
- On: indicate the program about to run, or indicate the selected mode or indicate the water level
- Flashing: indicate the running program

- It displays "--" during detecting.
- It displays total remained time during the running program (min).
- It displays remained reserved time during reserve program hour
- It displays abnormal symbol in abnormal situation. (See to Page 14)

- The digitron displays the time remained (in minute) before the washing is finished.
- Push down the reserve button. The reserve indicator light is on the digitron displays the reserve time of finishing washing (in hour).
- When the machine is started, the reserve indicator light is on, indicating that the reserve function is running.

- The washing machine can detect the laundries automatically during After detection, it will set the water level to suitable value among 46L 60L 72L automatically during the STANDARD program.
- The water level decided may be different from actual value because of the different moisture level of the laundries.
- You can also set water level by yourself. After the machine is started, it will not set water level automatically. You shall push the start/pause button to make new setting.
- If there's water inside the tub, the machine cannot detect the laundries and will display water level 60L. If wet laundries are put in, it may display water level 72L. You must set suitable water level by yourself.
- If quick program is selected, it will display water level 38L.
- If tub dry program is selected, the water level will not respond.
- During operation of wash and rinse program, you can push down the waterlevel button to add water. When you release the button, or it reaches the overflow water level, the machine will stop adding water.
- Rinse water level is more first level than washing (except the highest water level and hand choosing rinse water level).

- Push the On/Off button to switch on the power.
- When the power is on, push it again to switch off the power. Push the On/Off button to switch on the power.
- If the start/pause button is not pushed, the washing machine will automatically switch off the power after 5 minutes.

After the power is switched on, press it to start the machine.

- During working, push it to pause.
- During pause, push this button to restart and go on working



Program	Applicable situation
SOAK	Washing the relatively big thick or very dirty laundries
STANDARD	Common washing If "STANDARD" program is set, the machine will execute fuzzy detection. The computer will set the water level and wash time as per the cloth and quantity of the laundries. The whole procedure is under automatic control.
SOFT	Washing the woollen textiles
QUICK	Posthaste wash of the laundry under 2.0 kg with light soil. The water level will automatically set 38L.
WASH	Just run the washing cycle without drainage cycle. The detergent was left inside the drum and can be recycled.
RINSE	Remove the left detergent from the clothes and then rinse the clothes
SPIN	When the clothes are washed or the clothes are quite wet, extra spin is needed.
TUB DRY	The purpose is drying the inner tub and the outer tub, which can avoid growing

Steps of using the operation buttons

1 Push “  ” button to switch on the power

2 Push “  ” button to select suitable automatic program

- After the power is switched on, “SOAK” is automatically set. To select other fully-automatic program, please push the “PROGRAM” button till the corresponding indicator is on. Refer to the “Program” button on Page 11.
- When the “soak” is selected, after the water start to jet, the program wash, rinse and spin will be implemented (low water level soak for 25 minutes, mid level 35 mins high level 45 mins)
- Push PROGRAM button for 8 times, and it will resume the initial mode. It will circulate sequence.
- Water pressure and water level influence the wash time.
- Even there's no water in the tub, the spinning will start after a certain period.
- Wash and spin after putting the damageable clothes into tuck net, to avoid scathe.
- Wash the laundries that are prone to lose colors separately from other laundries.
- When washing start or opening cover intermitting, the washing machine will begin to work after a period time, this is normal phenomenon.
- Only select RINSE program, if there's water inside the tub, the machine will spin before rinsing, if there's no water the machine will rinse directly.

3 Push “  ” button, select suitable water level

- After switching on the power, the washing machine will execute fuzzy program automatically to detect the cloth during the standard program. After defection, it can set the water level automatically. To select other water level, first push the “START/PAUSE” button, then push the “WATER LEVEL” button to set the water level.
- The pulsator will not rotate unless the water is filled to selected water level.

4 Push “  ” button to select suitable reserve wash program

After switching on the power, the reserve program is set to off mode automatically. If you need to set the washing procedure to be finished at reserved time, please push the “RESERVE” button to set the reserve wash program. Refer to reserve button in Page 11 for selection.

Confirm the operation of reserve program

- When the “RESERVE” function is activated, the indicator light of the program you have set will be off. The “RESERVE (HOURS)” and “REMAIN MINUTES” indicator lights will be on. During reserve procedure, push the “RESERVE” button to display the reserve mode.
- To change the running program or cancel the reserve setting, you need to switch off the power and make new selection.



The washing will finish about 18 hours later

5 Push “  ” button, close the top lid

- If the top cover is opened when the machine is spinning, the machine will stop running and alarm.

6 Finish washing

- After Finishing washing, it will switch off power automatically.

Disposal after washing

- Please first pull off the power plug from the receptacle before cleaning.
- After using, please clean the lint and foreign materials of the lint filter and overflow filter in time. Otherwise it may influence your using the machine.

Clean the detergent box and set it on the control panel seat.

- 1** The method of dismantle: Push it up aslant and gently.

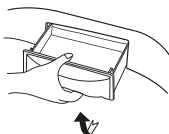

Dismantle

- 2** The method of install : install it upwards and aslant and push it in.

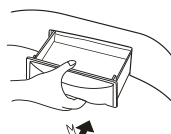

Install

Cleaning the lint filter

- 1** Push down the spring piece of the top lint filter to make the claws out of the filter cover, and then pull out the lint filter to get it down.

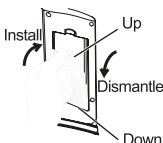

- 2** Pull the back of the lint filter, and then you can get down it off the front cover of the lint filter. Sweep the rubbish in the lint filter. Put the back of the lint filter into the front cover .

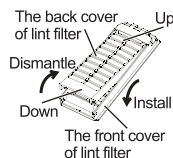

- 3** Put the lint filter into filter cover, and make it tight .

- 4** Make sure the lint filter well installed, or it can influence your use.

Notes:

- The filter screen of the water inlet valve is likely to be blocked by foreign materials and influence the water inlet. Please clean it with brush every two months.
- If the cabinet is dirty, wipe it with wet cloth
- Do not flush it directly with water.
- Wipe it with neutral detergent.
- Do not wipe it with thinner, petrol, alcohol etc.
- After washing, close the water faucet.
(If needed, you can dismantle the water inlet hose).
- Do not store water in the washing machine for a long period.
Drain the water completely after each using.
- Be sure to pull off the power plug before maintenance.
- Hang up the power cord.
- Wipe off the water drops on the surface of the machine and inside the tub. Open the top lid for some time (about 1 hour), then close the top lid.

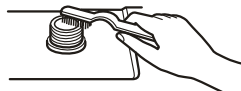

Trouble-shooting Answer to question

(If there's breakdown, please pull off the power plug before checking)

The following phenomena are not breakdowns sometimes. Please confirm again before sending it to repair.

If there are real breakdowns, please come to the special maintenance department or after-sale service department of our company. Do not repair it by yourself.

Phenomenan		The reason	How to settle
The digitron displays E0.		<ul style="list-style-type: none"> ●The top lid is opened during reserve procedure. 	<ul style="list-style-type: none"> ▶ Close the top lid.
The drainage cannot work, or is too slow. The digitron displays E1.		<ul style="list-style-type: none"> ●Is the drain hose blocked? ●Is the drain hose put down? 	<ul style="list-style-type: none"> ▶ Clean the foreign material. Open and close The top Lid Once. ▶ Put down the drain hose. Open and close the top lid once.
It stops running in midway. The digitron displays E2.		<ul style="list-style-type: none"> ●The top lid is not closed. 	<ul style="list-style-type: none"> ▶ Close the top lid.
The safety switch acts, and the spinning cannot work. The digitron displays E3.		<ul style="list-style-type: none"> ●Are the laundries put slantingly? ●Is the machine slanting? 	<ul style="list-style-type: none"> ▶ Reorder the laundries. Close the top lid. ▶ The machine will start running after 10 seconds of being placed horizontally.
The water filling does not work, or is slow, the digital displays E4.		<ul style="list-style-type: none"> ●Is the water tap opened, or is there water supply failure? ●Is the water inlet valve blocked? ●Is the water pressure too low? 	<ul style="list-style-type: none"> ▶ Open the water tap. Push the start/ Pause button once. ▶ Clean the water inlet valve then push the start/Pause button once. ▶ Use after the water pressure is normal.
The digitron displays E6.		<ul style="list-style-type: none"> ●The water level sensor is bad. 	<ul style="list-style-type: none"> ▶ Please contact the after-sales service department.
The machine does not act	Not wash	<ul style="list-style-type: none"> ●Is there power failure? ●Is the power plug inserted tightly? ●Is the water level reached preset position? 	<ul style="list-style-type: none"> ▶ Please use it when there's power supply. ▶ Insert the power plug tightly. ▶ Fill water to the preset position.
	Not spin	<ul style="list-style-type: none"> ●Is the power plug inserted tightly? ●Is the top lid closed reliably? ●Are the laundries set flat? 	<ul style="list-style-type: none"> ▶ Insert the power plug tightly. ▶ Close the top lid. ▶ Set the laundries flat.
There's abnormal sound inside the machine		<ul style="list-style-type: none"> ●Is the machine slanting? ●Are the laundries put slantingly in spinning? ●Are there any foreign materials? 	<ul style="list-style-type: none"> ▶ Adjust the machine to be even. ▶ Reorder the laundries and close the top lid. ▶ Remove the foreign materials.
The water tap leaks		<ul style="list-style-type: none"> ●Is the jointer of water inlet hose loose or awry? 	<ul style="list-style-type: none"> ▶ Fasten the jointer properly.

Common phenomena

Phenomena	Explanation
The spinning is intermittent when it starts.	Balance the laundries to avoid slanting.
Push the "spin" button to select "Spin", but it doesn't work.	The program is setting the drain time. Some time is needed before it starts spinning.
The final spinning is finished, it becomes rinsing and begins to inlet water.	Because the washing clothes lean to one side, the safety switch acts. After water filling and running, eliminating the eccentricity of washing clothes, then beginning to spin.
When the power plug is inserted, computer board indicator is switched on, and the machine starts working.	It is the special resume function. In the case of power failure or the power plug is loose during washing, the machine can save the running program, and resume the program after the power supply is recovered. You do not need to set the program again.

Specification

Rated voltage/Frequency	220-240V ~ /50Hz
Water level / Water quantity (about)	1/20L, 2/29L, 3/38L, 4/46L, 5/54L, 6/60L, 7/66L, 8/72L
Injection pressure	0.03 MPa ~ 1.0 MPa
Washing/Spinning capacity	8.5kg/8.5kg

Haier